

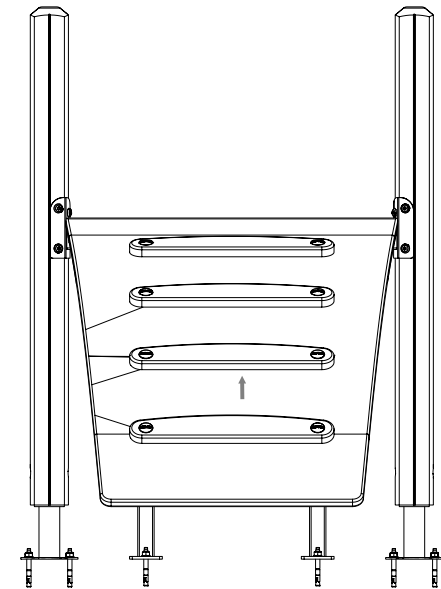











**OM**



1	SW89474		1 x Ramp	14.73 kg
2	43-07232		6 x Ø6 16/7 x 3 mm	0.00 kg
3	8008651		6 x Screw, wood, TKFT-6x40-8.8	0.01 kg
4	SW89817		2 x Anchor leg	0.88 kg
5	8008557		4 x Expansion anchor M8x71 HDG	0.08 kg
6	43-04810		4 x Cap 6 Ø6,5x21 mm	0.00 kg
7	8008848		4 x Washer, Bolt cap 6.4x14x1.6-ISO4759-3-C	0.002 kg
8	8008336		2 x Screw, ISO4014-M6x45-8.8	0.0126 kg
9	43-04812		2 x DISTANCE 6 Ø7x27x2,5	0.00 kg
10	8008794		2 x Nut, Fujilok-M6-8-RingA2	0.002 kg
11	43-04811		4 x Cover M6, Ø15x10mm	0.00 kg

