

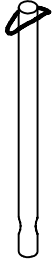

TYPE	HAGS NO.
	177803
	177572

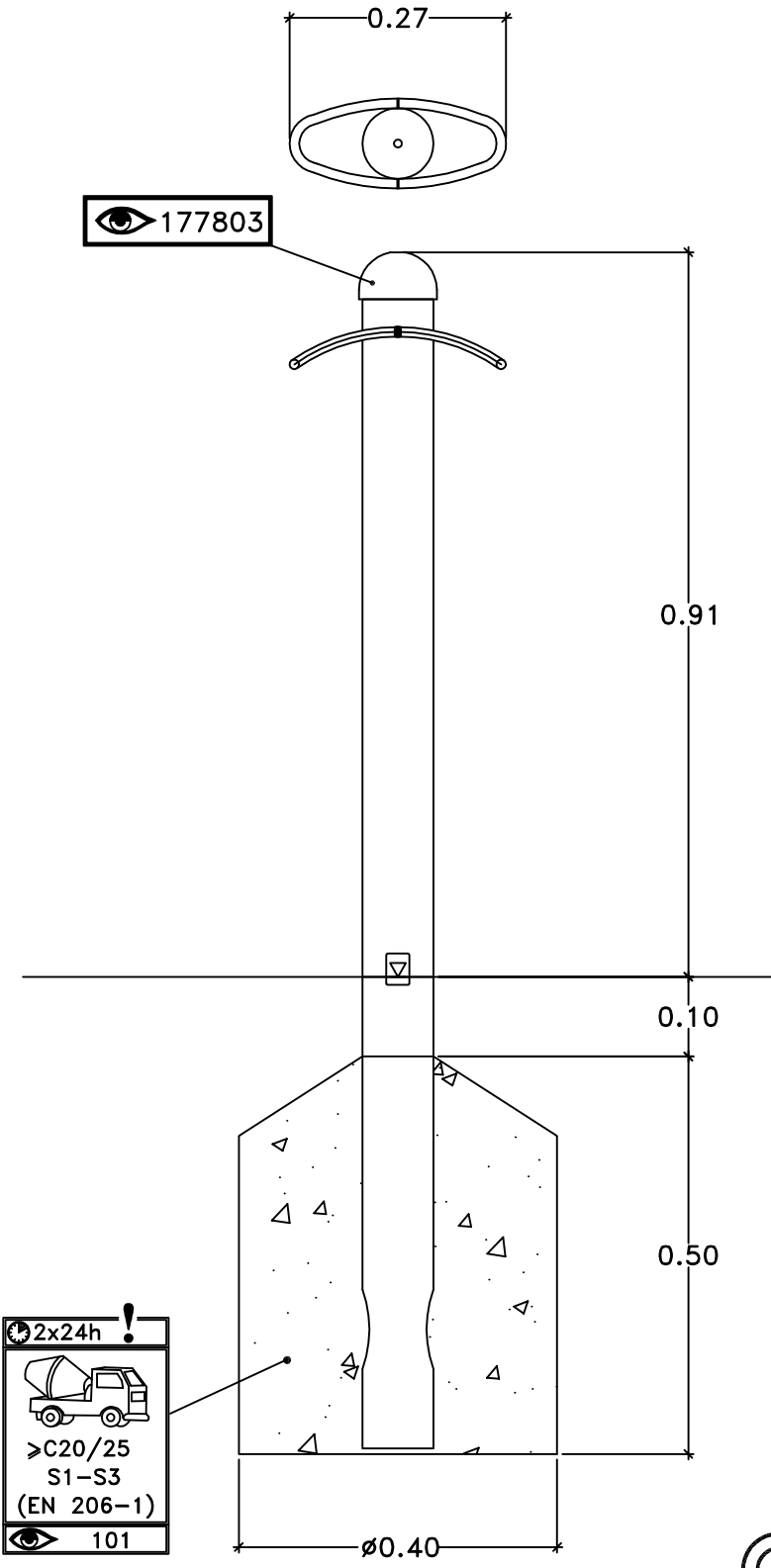



 2x24h !

 >C20/25

 S1-S3

 (EN 206-1)

 101

HAGS

 ANEBY, SWEDEN

 +46(0)380-47300

 www.hags.com

178143

 Dca

 Acj

 2003-04-10 | 2