

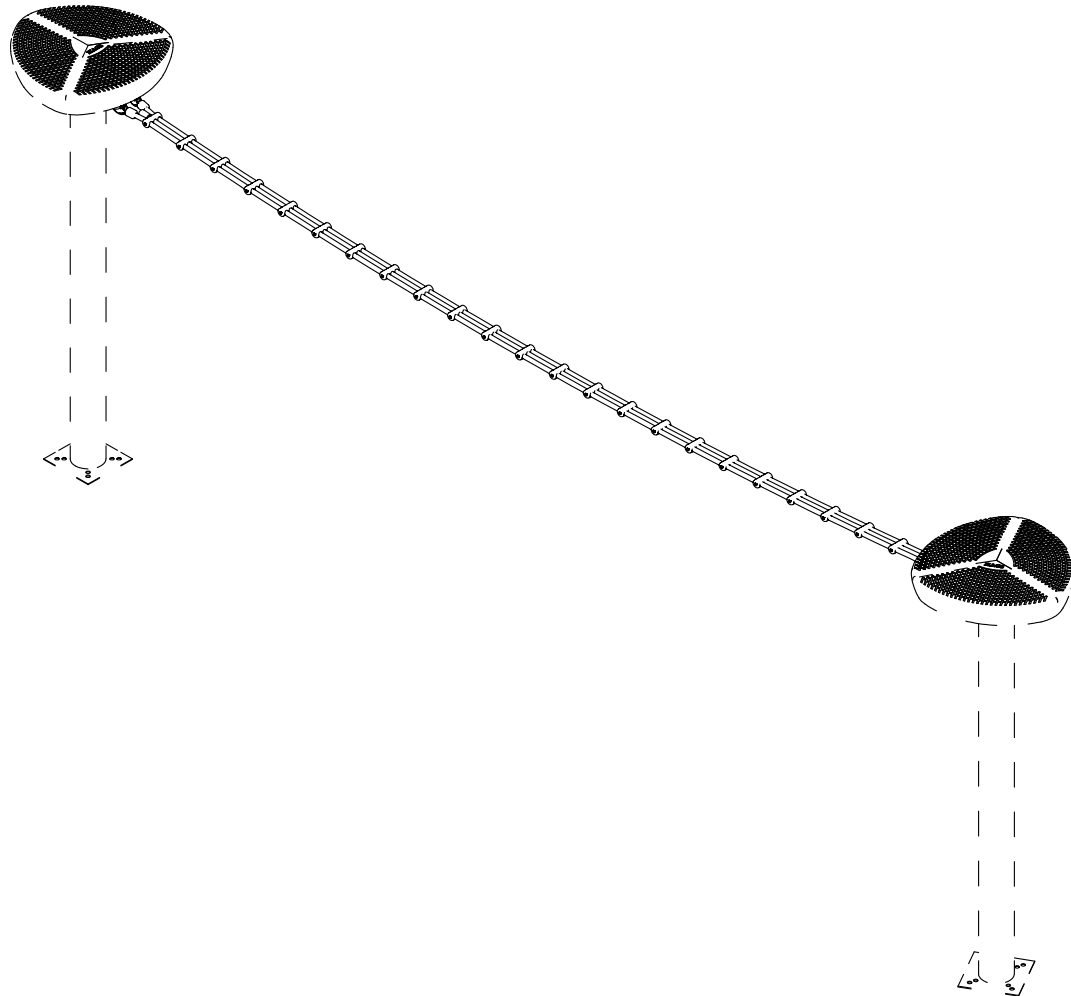

HAGS

Slackline 4M

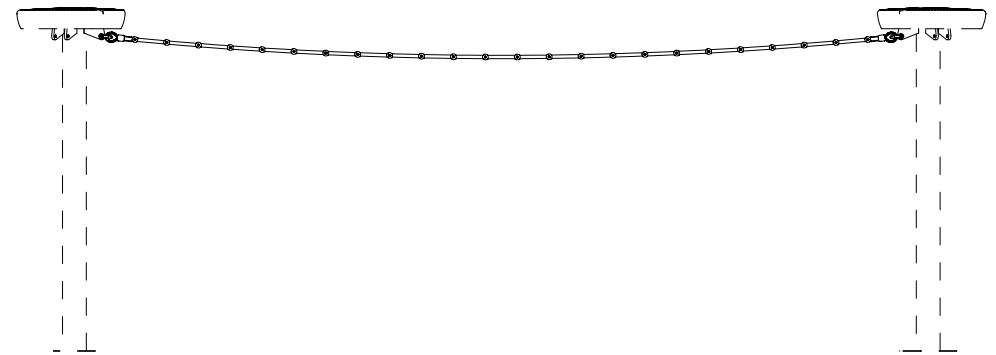



CC





1	76701004		1x 3849mm x 65mm	5.9kg
---	----------	--	------------------	-------

2	SW75437		4x 36mm x 16mm x 16mm	0.02kg
---	---------	---	-----------------------	--------

S6 
EN1176
0.45M

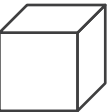
S12 
kg
5.98kg

S15 
L x W x H (m)
3.849 x 0.134 x 0.111 m

S20 
1 x 1

S8 
ASTM F1487
18.0"

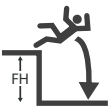
S9 
CSA Z 614
0.45m [18.0"]

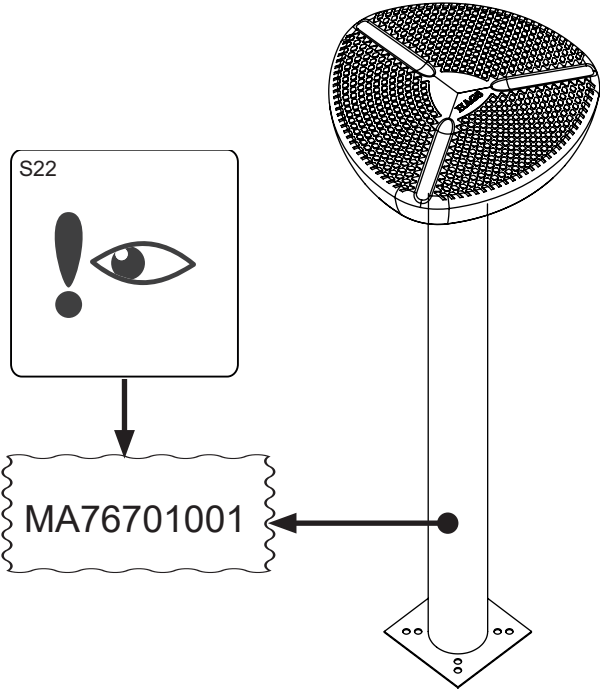
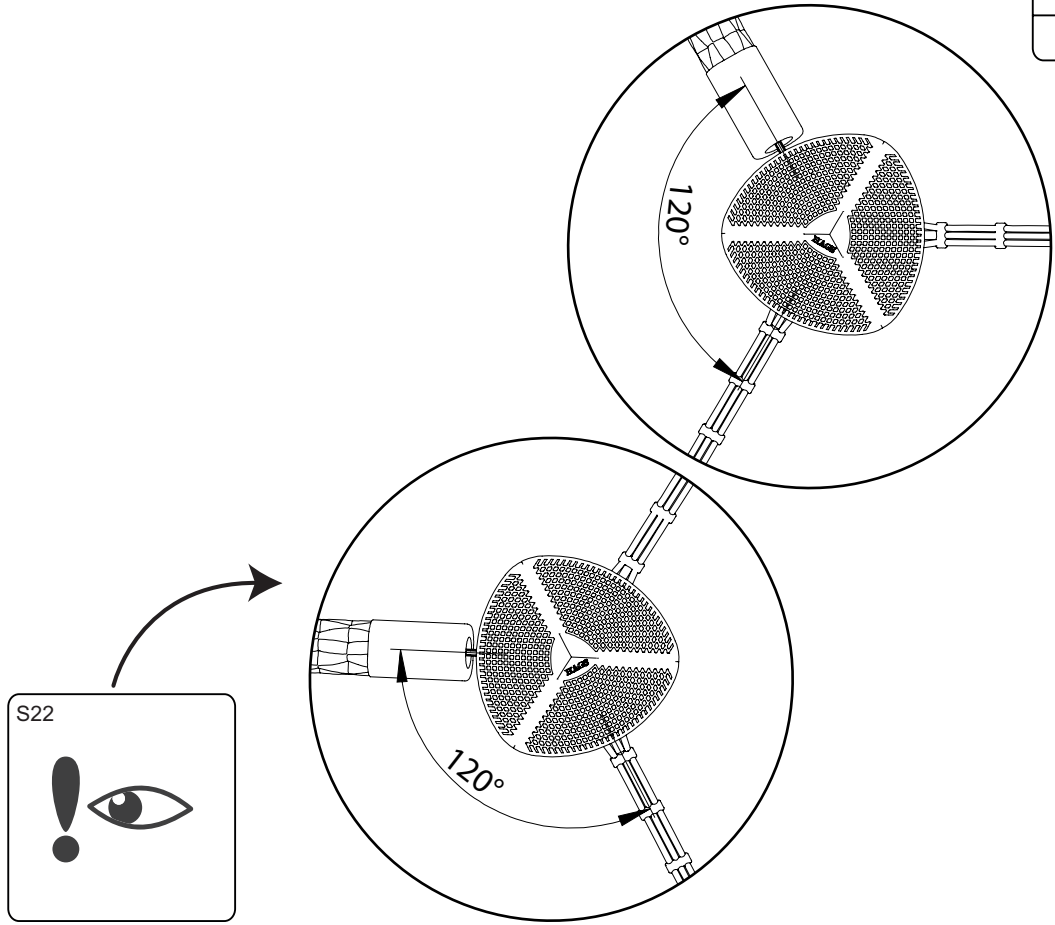

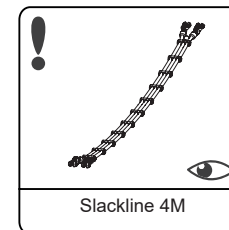
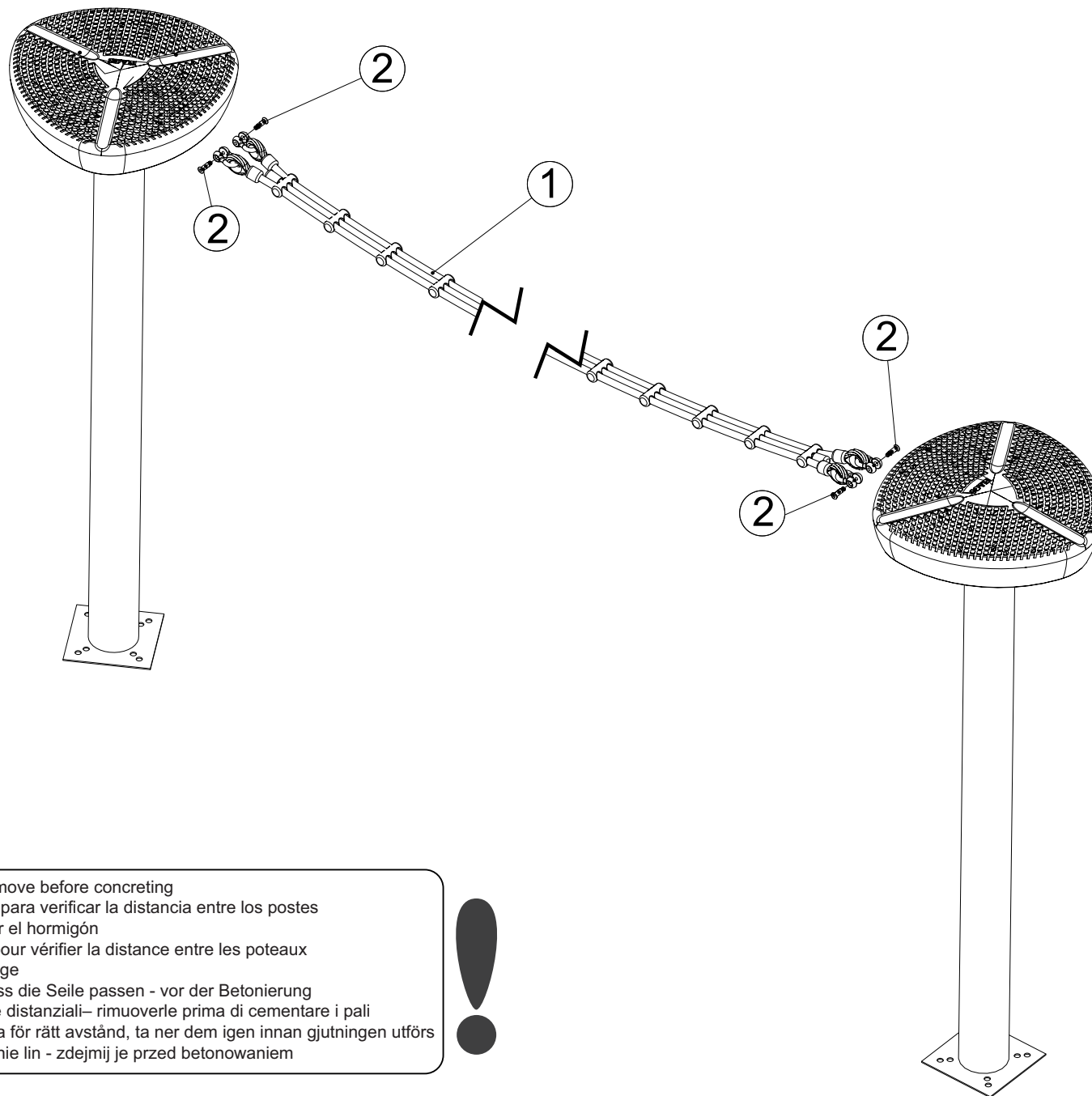

GB - Verify ropes fit – remove before concreting
ES – Utilizar las cuerdas para verificar la distancia entre los postes
 - quitarlas antes de poner el hormigón
FR – Utiliser les cordes pour vérifier la distance entre les poteaux
 -les retirer avant bétonnage
DE – Überprüfen Sie, dass die Seile passen - vor der Betonierung
IT – Usare le corde come distanziali- rimuoverle prima di cementare i pali
SE – Provmontera linorna för rätt avstånd, ta ner dem igen innan gjutningen utförs
PL - Sprawdz dopasowanie lin - zdejmij je przed betonowaniem



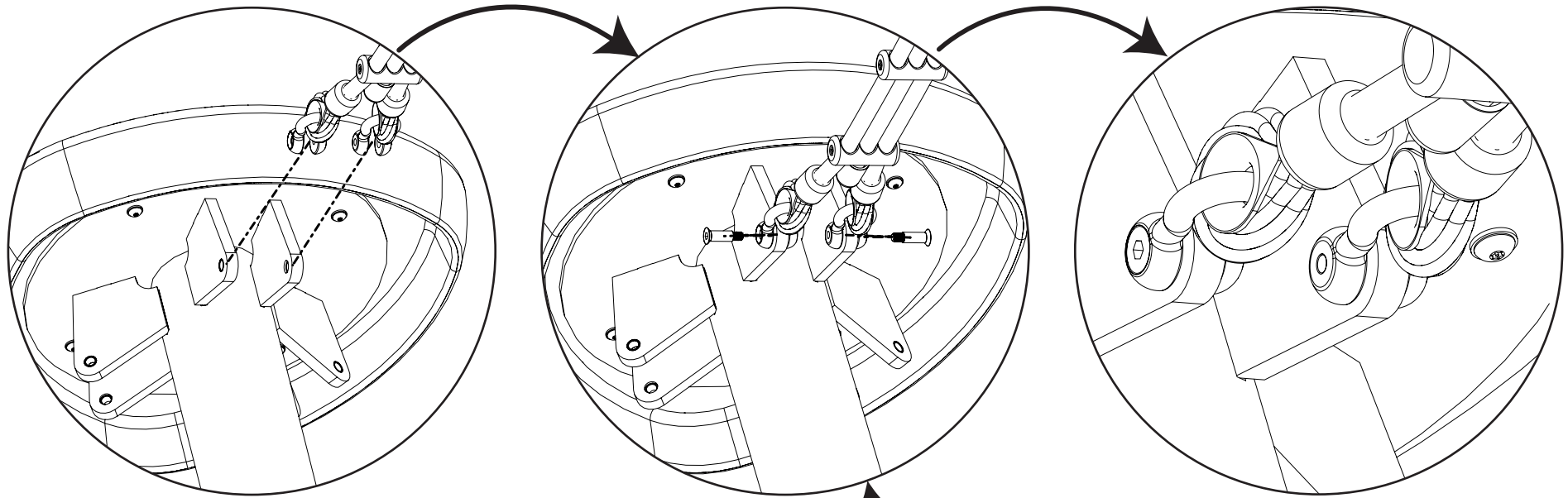

S11

Nm
20-25 Nm

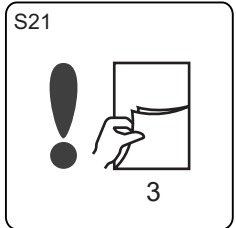
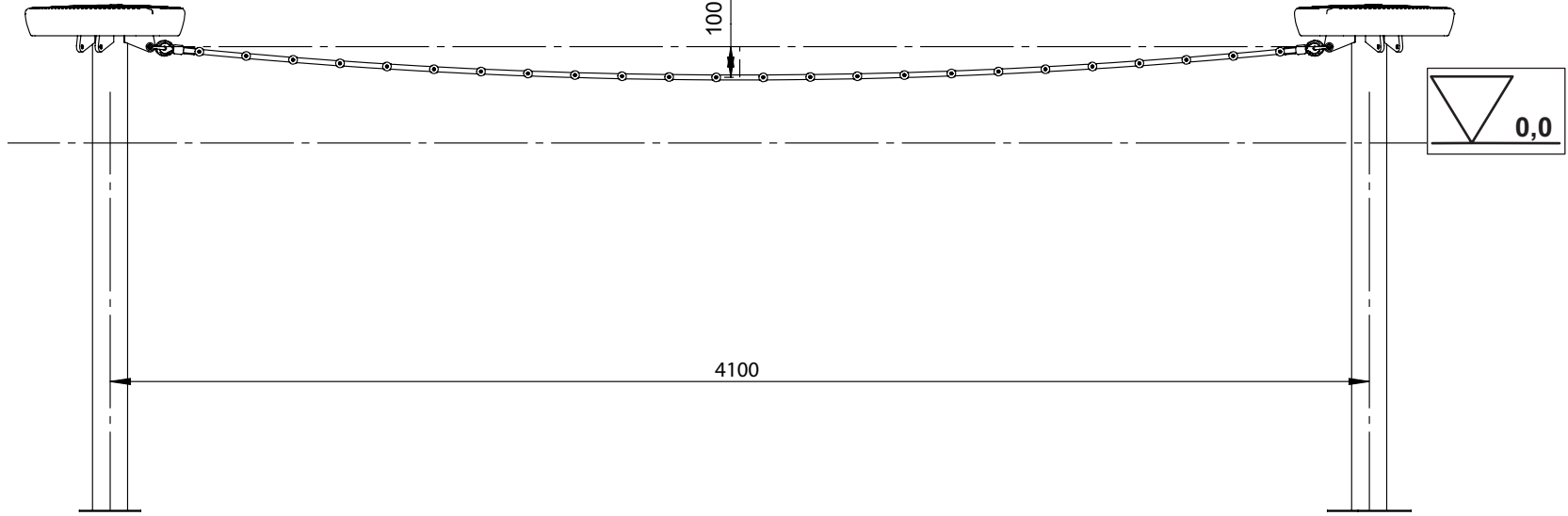

100 (+30/-0)

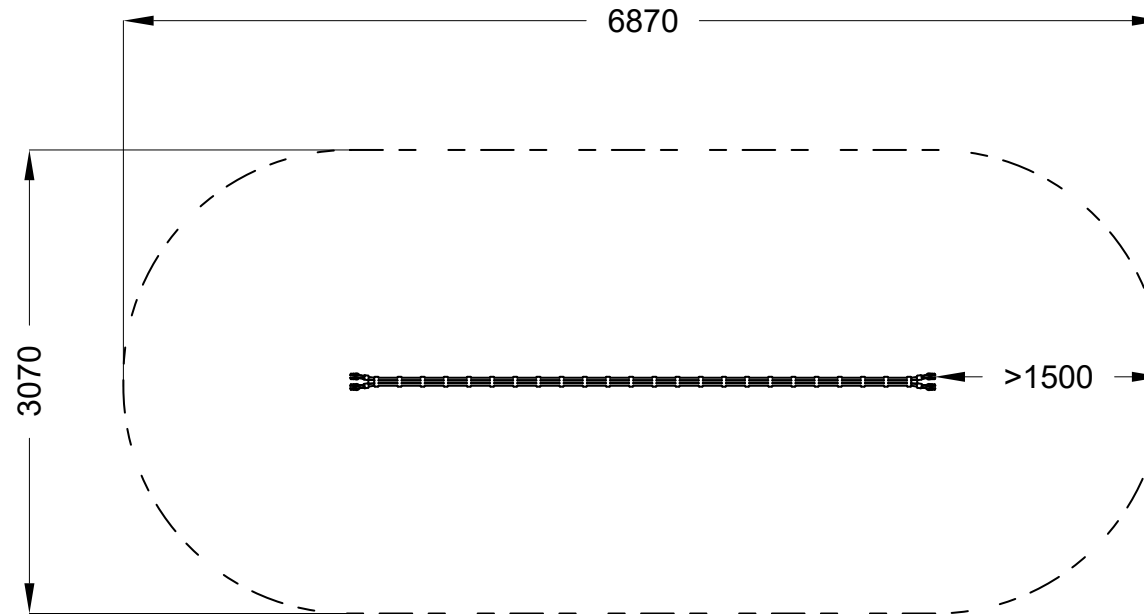
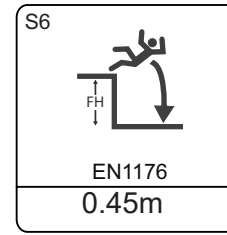

A



B

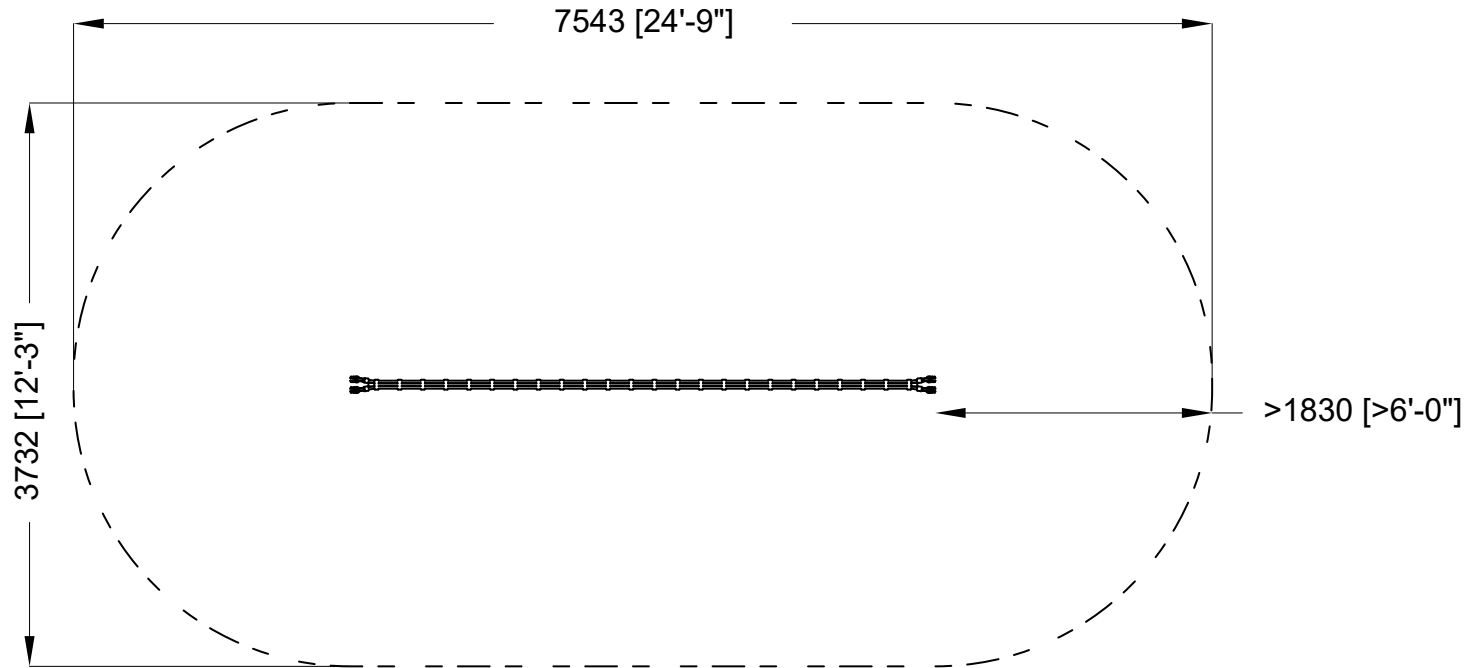
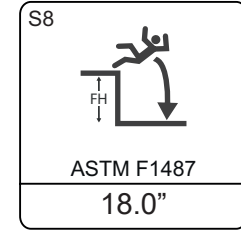

WARNING
Playground equipment installed over hard surfaces such as concrete, asphalt or packed earth may result in serious injury or death from falls. Make sure that appropriate safety surfacing is present, before allowing children to play.

WARNING
Children have strangled and died while their clothes caught on slides and other playground equipment. Before allowing children to play, remove helmets, scarves, necklaces, hood cords, neck drawstrings, and mittens connected through the sleeves. Also, remove any foreign ropes, strings, or shoe laces that may be tied to equipment.

WARNING
All playground equipment and rubber surfacing may become hot enough to cause burns. Check for hot surfaces before allowing children to play. Children should wear appropriate shoes at all times.

WARNING
Playing tag or running on or under playground equipment can lead to serious injuries from falls, collisions, and head strikes. Do not run on or under playground equipment. Pay attention while playing and be careful.

“play smart” rules

- ✓ Do not play on broken or damaged equipment. Report it.
- ✓ Do not play without adequate safety surfacing below and around equipment.
- ✓ No helmets, necklaces or drawstrings should be worn while on equipment.
- ✓ Be careful of hot paly surfaces and always wear shoes while playing.
- ✓ Do not play tag or run on playground equipment and do not jump off of equipment.
- ✓ Watch your head! Do not run under bridges, decks, stairs, or other equipment.
- ✓ Be careful when equipment is wet. Do not play on snowy or icy equipment.
- ✓ Do not climb on roofs, railings, or posts, or on top of crawl through tube slides.
- ✓ Slide sitting down, feet first, and one at a time. Do not slide up chutes or tubes.
- ✓ Adults – do not slide with a child on your lap. It can injure your child’s legs.
- ✓ Before letting go of overhead bars, hang down still, bend your knees a little and drop straight down with both feet.
- ✓ Swing sitting down and do not jump out while swinging. Do not twist chains.

C

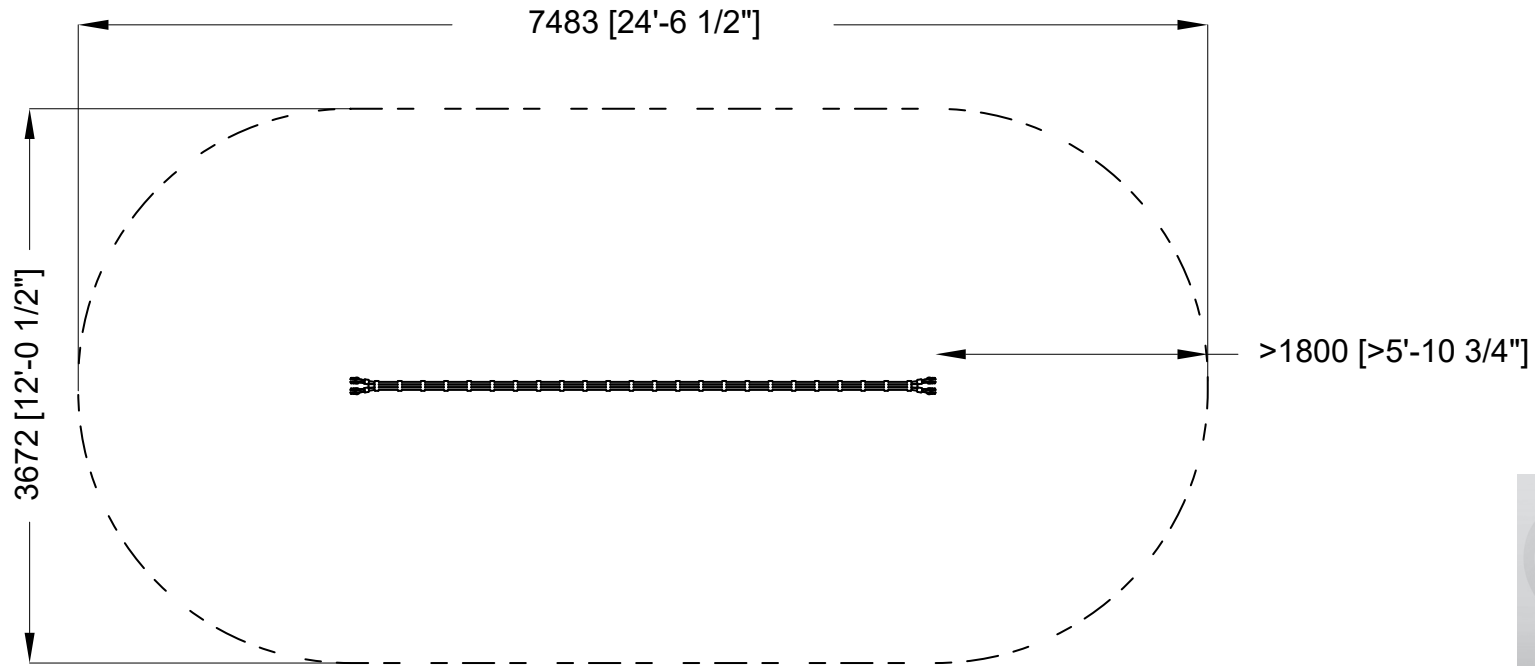
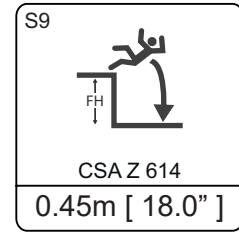

WARNING
Playground equipment installed over hard surfaces such as concrete, asphalt or packed earth may result in serious injury or death from falls. Make sure that appropriate safety surfacing is present, before allowing children to play.

WARNING
Children have strangled and died while their clothes caught on slides and other playground equipment. Before allowing children to play, remove helmets, scarves, necklaces, hood cords, neck drawstrings, and mittens connected through the sleeves. Also, remove any foreign ropes, strings, or shoe laces that may be tied to equipment.

WARNING
All playground equipment and rubber surfacing may become hot enough to cause burns. Check for hot surfaces before allowing children to play. Children should wear appropriate shoes at all times.

WARNING
Playing tag or running on or under playground equipment can lead to serious injuries from falls, collisions, and head strikes. Do not run on or under playground equipment. Pay attention while playing and be careful.

"play smart" rules

- ✓ Do not play on broken or damaged equipment. Report it.
- ✓ Do not play without adequate safety surfacing below and around equipment.
- ✓ No helmets, necklaces or drawstrings should be worn while on equipment.
- ✓ Be careful of hot paly surfaces and always wear shoes while playing.
- ✓ Do not play tag or run on playground equipment and do not jump off of equipment.
- ✓ Watch your head! Do not run under bridges, decks, stairs, or other equipment.
- ✓ Be careful when equipment is wet. Do not play on snowy or icy equipment.
- ✓ Do not climb on roofs, railings, or posts, or on top of crawl through tube slides.
- ✓ Slide sitting down, feet first, and one at a time. Do not slide up chutes or tubes.
- ✓ Adults - do not slide with a child on your lap. It can injure your child's legs.
- ✓ Before letting go of overhead bars, hang down still, bend your knees a little and drop straight down with both feet.
- ✓ Swing sitting down and do not jump out while swinging. Do not twist chains.