









BOM ID	IMAGE	QUANTITY	DESCRIPTION	DOCUMENT ID	WEIGHT
4		16	Washer	43-07232	0.00
5		4	Expansion anchor M10x86 HDG	8008561	0.04
7		16	Screw, wood, TKFT-6x40-8.8	8008651	0.01
8		8	Screw, wood, TKFT-8x60-8.8	8008646	0.02
6		8	Countersink washer 8	SW33168	0.0
2		1	Protection pipe, Straight, for Wooden Post	SW37573	2.63
3		2	Handle f. wooden post	SW39776	0.83
10		1	Anchoring plate, OM	SW69762	1.95
1		1	Wobble Climb, OM	SW70048	40.46

BOM ID	IMAGE	QUANTITY	DESCRIPTION	DOCUMENT ID	WEIGHT
--------	-------	----------	-------------	-------------	--------





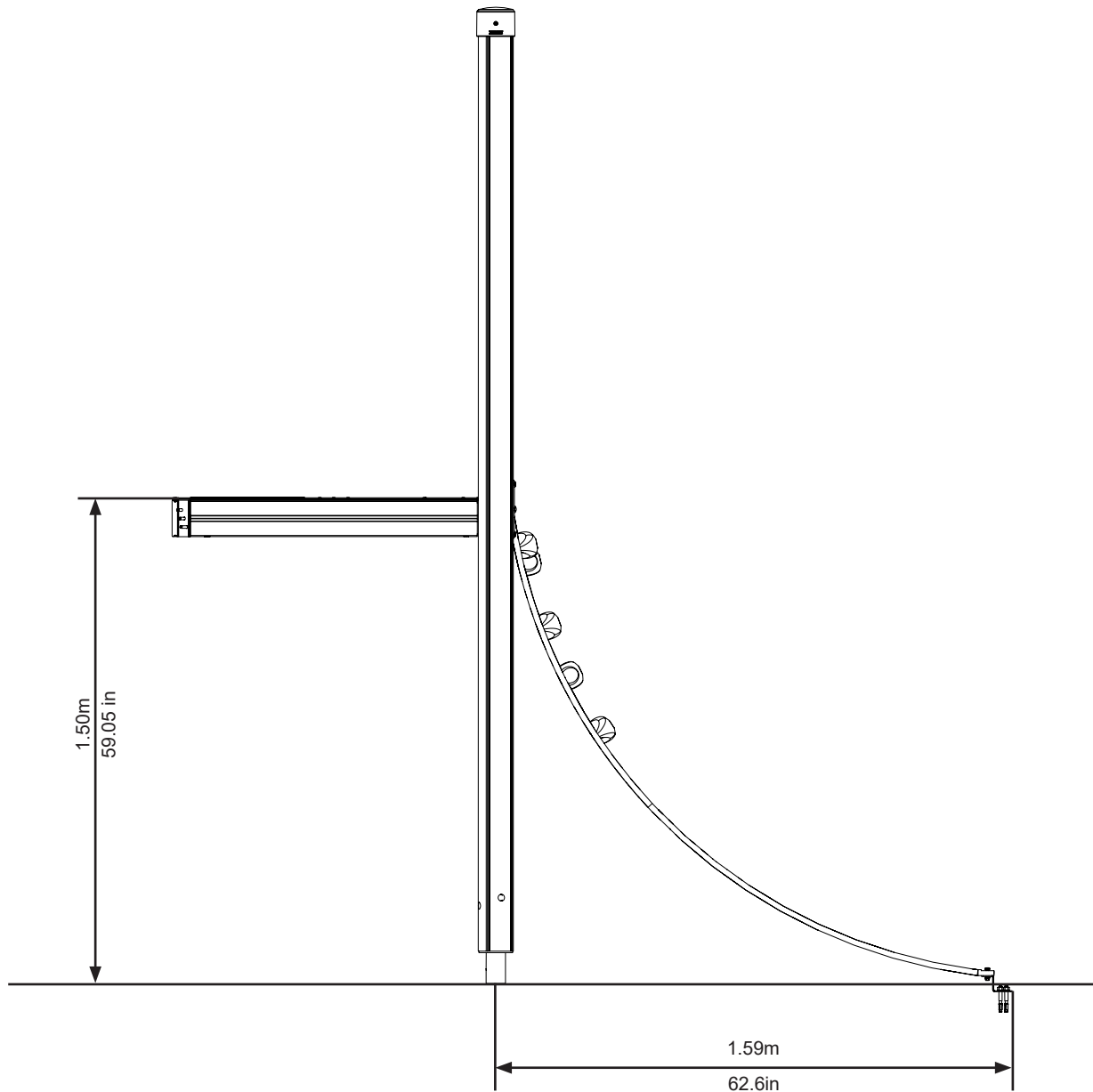
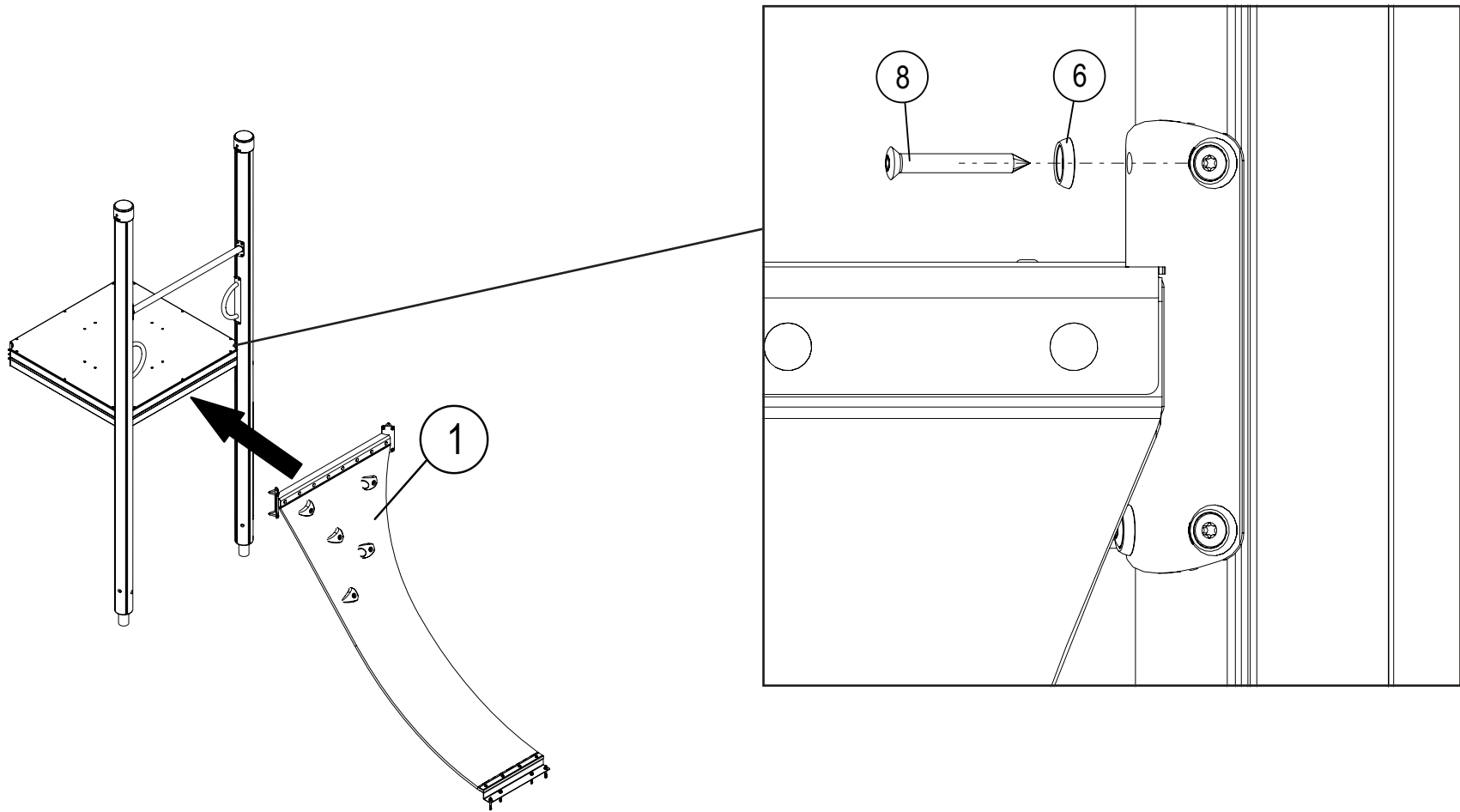
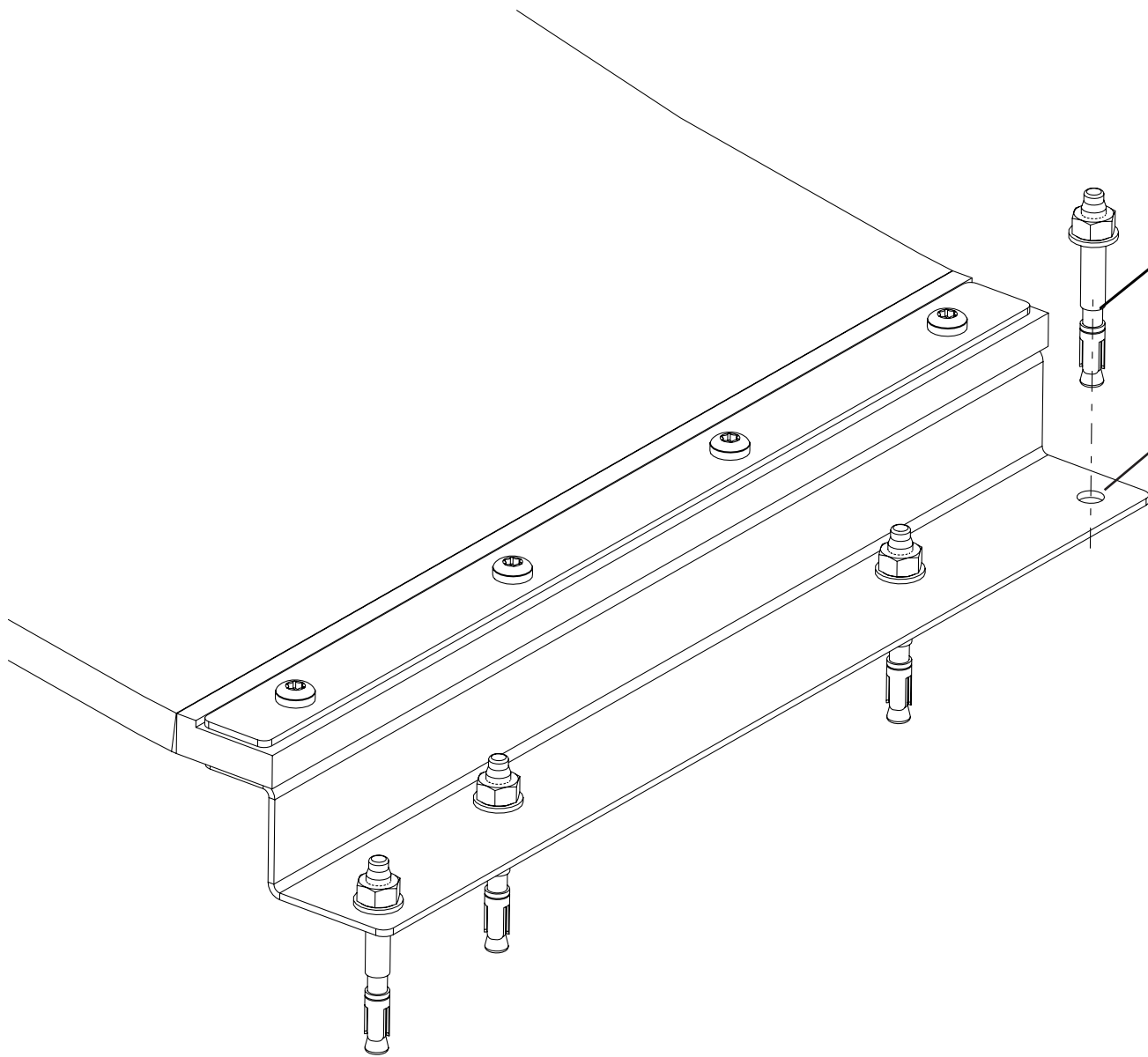

5

mm
Ø10x4

Depth
80mm

